

Connection and operation manual

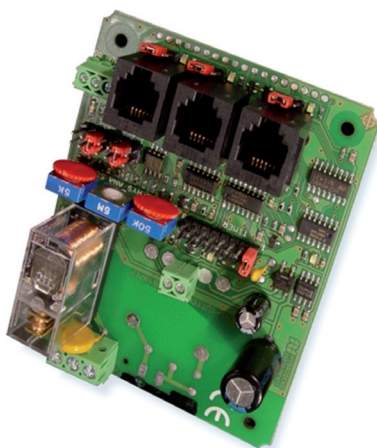

Universal sensor switching module 24 V OEM-Version without housing

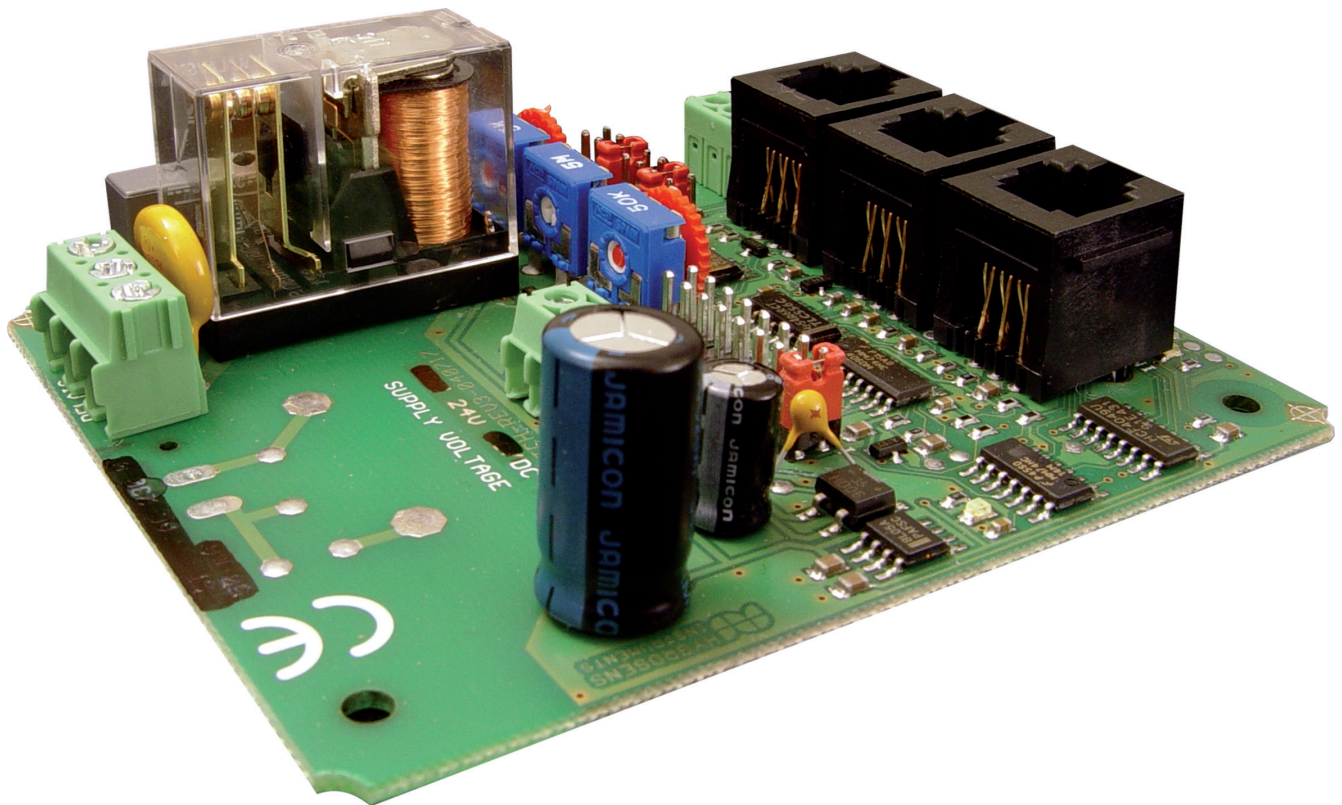

- Two point regulator for sensors and probes
- For industrial probes 0...1 V, 0...10 V, 0/4...20 mA
- Direct connection of NTC, LDR, PTC
- Input with AC-evaluation (conductance)
- Adjustable delay timer 10 s..10 min
- High rating, potential free relays
- Operating voltage as per model:
12 V/24 V AC/DC or 230 V AC

Connection and operation manual

Universal sensor switching module 24 V OEM-Version without housing

1	General dangers and precautions	4
1.1	Instructions regarding documentation	4
1.2	Safety instructions	4
2	Description	4
2.1	Functional description	4
2.2	Range of available probes	5
2.2.1	Dew formation probe (Condensate monitor)	5
2.2.2	Humidity probe	5
2.2.3	Conductance probe	5
2.2.4	Temperature probe with protection tube	5
2.2.5	Temperature probe with screw threads	5
2.2.6	Light intensity probe	6
3	Technical data	6
4	Ordering information	6
5	Assembly, adjustment and configuration	7
5.1	Electrical connection	7
5.1.1	Safety instructions	7
5.1.2	Probes	7
5.2	Configuration	7
5.3	Adjustment of switching point	7
5.4	Adjustment of time delay	7
5.4.1	Operating voltage	8
5.4.2	Load circuit	9
6	Technical appendix	9
6.1	General instructions	9
6.2	Switching input	9
6.2.1	Circuit diagram	9
6.2.2	Functional description	9

Connection and operation manual



Universal sensor switching module 24 V OEM-Version without housing

6.2.3	Configuration of switching input socket (RJ12)	10
6.2.4	Adjustment and configuration	10
6.2.5	Operating voltage connection	10
6.3	Impedance input	10
6.3.1	Circuit diagram	10
6.3.2	Functional description	11
6.3.3	Configuration of input socket RJ12	11
6.3.4	Adjustment and configuration	11
6.3.5	Operating voltage connection	11
6.4	Analog input	12
6.4.1	Circuit diagram	12
6.4.2	Functional description	12
6.4.3	Configuration of analog input socket RJ12	13
6.4.4	Adjustment and configuration	13
6.4.5	Operation modes	14
6.4.6	Operating voltage connection	14
6.5	Time delay switch	14
6.5.1	Jumper connections	15
6.6	Relay	15
7	Guarantee	15
7.1	Repair and calibration service	16



Universal sensor switching module 24 V OEM-Version without housing

1 General dangers and precautions

1.1 Instructions regarding documentation



Please carefully read the following instructions before putting into operation! The symbols used in the operating manual are to make you careful, before hand, regarding safety considerations and dangers. But all these symbols cannot substitute the text of the associated safety instructions in any way. Therefore, the instructions should also be always read completely!



This symbol indicates likely danger for persons, material or environment. The information provided in the associated text should be duly followed to avoid any kind of risk.



This symbol refers to important application notes and tips, which are necessary for successful working and should to be absolutely followed to ensure good results.

1.2 Safety instructions



Please read these instructions, carefully and completely, before putting the device into operation. Please also comply and follow the safety instructions, specially the safety regulations related to the devices being operated on mains supply.

The product should be installed and used only for the intended applications as described in these instructions. Any other application is not advised and shall lead to loss of guarantee and exclusion from liability. This also applies to any changes or other modifications carried out on the device by the user.

Defective safety devices should be replaced with same type of items in respect of trip current rating, tripping characteristics, and mechanical fitment dimensions. Bypassing protections lead to a considerable safety risk and are not allowed under any circumstances.

The connection terminals can be wired to mains voltage. Contact with live parts lead to fatal dangers. The mounting and maintenance operations should be carried out by only trained personnel, who are authorised on the basis of technical training in this field. The applicable safety regulations should be followed. The switching device must be assembled in a switchgear cabinet or a fully closed plastic housing. Mounting and servicing operation should be carried out only after switching off the voltage.

The product is not meant for controlling electrical systems, which perform safety related functions. In normal operation also, there is always a danger of malfunctioning due to failure of any component or any other disturbance. The user has to ensure that there are no consequential damages due to malfunctioning or undefined switching status of the relay. This is all the more possible, if heavy loads like heaters or motors are triggered with the relays.

2 Description

2.1 Functional description

The universal sensor-switching module is suitable as a two-point regulator for a wide variety of sensors and industrial probes. A suitable sensor is connected at the input for sensing the parameter which is to be regulated. The relay mounted on the PCB gets triggered as per limit settings done through a potentiometer.

For universal application, the device is provided with three different type of inputs, which are internally connected and can be used individually or together:

- **Input 1:** A Schmitt-trigger input with high pass filter for switching sensors like Reed-contacts, alarm-circuits, pushbuttons, light barriers, message contacts or motion alarm unit. Switch contacts, Open-collector outputs or sensors with binary voltage output 0/5 V can also be connected at the input.

Universal sensor switching module 24 V OEM-Version without housing

- **Input 2:** An AC-input for analog AC voltage impedance evaluation. This input is specifically meant for electrolytic sensors like conductance probes and level indicators, humidity and dew formation sensors or water/leakage probes.
- **Input 3:** An universal, analog voltage or resistance input and also for industrial voltage and current signals (0...1 V/5 V/10 V, 0...20 mA, etc.). This is also suitable for direct connection of resistive sensors like LDRs, NTCs or PTCs.

The three inputs can be used either separately or in combined form (i.e. internally wired or joined). The switching behaviour (active relay with upper and lower limits) of each input can be separately configured with its relevant jumper connection.

The three inputs are brought out through the RJ12 socket, to which standard probes, which are available as accessories can be connected or joined through soldering without much expenses. The voltage and resistance input (Input 3) is also additionally brought out through a 3-pin terminal strip. In addition, the device is provided with a time delay switch, which can be configured over a wide range (approx. 10 sec to 10 min). It is digitally configured with the help of a jumper connection. The adjustment of limiting values and Hysteresis is done with three potentiometers. The condition of device is displayed with a total of 6 LEDs. The high rating relay has a changeover contact. The NO contact of the relay can switch a load up to 230 V/5 A and is provided with a varistor for surge suppression.

Scope of supply

The scope of supply is without probe. Standard probes are available as accessories. The scope of supply of 12 V/24 V model is in the form of a PCB of size 95 x 75 mm without housing and operating panel. The 230 V model is supplied in a housing (100 x 100 x 60 mm) with integrated power supply unit and operating panel.

2.2 Range of available probes

The probes described below are available as accessories. The probe is provided with a 1 m long connection cable, PG-threads for mounting of housing and a ready made RJ12 plug connector. All commercial grade industrial probes with voltage and current output can also be operated with the device.

2.2.1 Dew formation probe (Condensate monitor)

The dew formation probe can recognise upcoming dew formation before it originates. The sensing unit has two independent sensor elements for dew formation and condensation, which are integrated together and have such a reliable response pattern so that it can also sense already formed condensation. Typical application areas are humidity monitoring for kitchen, bathroom, showers and toilets, monitoring of external walls, cooling ducts and display windows. The range of setting is right from 93 % to 97 % RH.

2.2.2 Humidity probe

The measuring probe is meant for regulation of relative humidity in green houses, fields, sanitary rooms, and switchgear cabinets. The integrated electrolytic humidity sensor inside the probe is protected with a hydrophobic sinter cap. The measuring range is right from 35...90 % RH and is not temperature compensated.

2.2.3 Conductance probe

The conductance probe is intended for monitoring of water quality (ion content), as a level switch or as a foam sensor. Measuring range is right from approx. 10 μ S...30 μ S.

2.2.4 Temperature probe with protection tube

The temperature probe with protection tube has a measuring range of -40 °C to 80 °C and is fitted with a high quality, oil resistant PUR connection cable. The protection tube with an outside diameter of 6 mm can be directly installed into a submerged sleeve. Typical areas of application are heating and solar systems as well as building instrumentation.

2.2.5 Temperature probe with screw threads

The temperature probe with screw threads M10 x 1.5 is pressure sealed up to 20 bar and is meant for direct measurement in the medium. The probe has a measuring range of -40 °C to 80 °C and is fitted with a high quality, oil resistant PUR-connection cable. Typical areas of use are industrial applications, pneumatics and hydraulics.

Universal sensor switching module 24 V OEM-Version without housing

2.2.6 Light intensity probe

The weatherproof light intensity probe is suitable for both indoor and outdoor applications. The measuring range is right from 50..20000 Lux. Typical areas of application are twilight switches or emergency lights.

Our delivery program is constantly updated. If you require any special type of probe, please do send your enquiry to us!

3 Technical data

General	
Operating voltage Type –230V	230 VAC/5 VA max.
Operating voltage Type –MOD12V	12 V...15 V DC 65 mA max. 11 V...14 V AC 80 mA max. (without probe)
Operating voltage Type –MOD24V	22 V...28 V DC 45 mA max. 15 V...25 V AC 60 mA max. (without probe)
Time delay switch	10 sec to 11 min +/-20 % configurable with jumper plugs
Relay	Changeover contact for resistive load NO contact rating 230 V AC / 5A NC contact rating 230 V AC / 2 A
Surge suppression	Suppression with a varistor VZ 05/390 V
Dimensions	Type –230V 100 x 100 x 60mm Supply in plastic housing Type –MOD PCB 95 x 75 x 30mm Supply only as a PCB
CE-conformance	2014/30/EU
EMV-noise emission	EN 61000-6-3:2011
EMV-noise withstanding	EN 61000-6-1:2007
Sensors	
DC Impedance input	0...1/10/100 kΩ; configurable with jumper plugs
Voltage/Current input	0...1 V/10 V/20 mA, configurable with jumper plugs
AC Impedance input	Series impedance 10 k...50 k Conductance 30 μS...10 μS
Switching input	NC/NO or voltage signal 0/5 V

4 Ordering information

Switching device an accessories	Ordering No.
Universal switching module, PCB for 12 V DC	0557 0005
Universal switching module, PCB for 24 V DC	0557 0005-01
Switching module 230 V, in housing with operating panel	0557 0005-02
Housing ET210F, unfinished	ET212-F
Probe with connection cable	Ordering No.
Dew formation probe	0636 0007
Conductance probe	0636 0002
Space humidity probe	0636 0001
Temperature probe with stainless protection tube	SENSW-TF-ESR
Temperature probe, pressure resistant with screw threads	SENSW-TF-M10
Light intensity probe, weather proof	0636 0005

Our delivery program is constantly updated!

Universal sensor switching module 24 V OEM-Version without housing

5 Assembly, adjustment and configuration

5.1 Electrical connection

5.1.1 Safety instructions



Caution ! Touching the high voltage parts may lead to fatal dangers. The mounting and maintenance operations should be carried out by only trained personnel, who are authorized on the basis of technical training in this field. The applicable safety regulations are to be duly followed! The switching device must be assembled in a switchgear cabinet or in a fully closed plastic housing. Mounting and servicing work should be carried out only after switching off the voltage.



Due to wrong tightening of screws of the connection terminals or by use of inappropriate tool, the terminals can get damaged because of which the insulation or the contact can get disturbed. Badly connected leads can come out during operation and cause a serious risk to safety. Due to contact resistance at terminal connections, there can be increased heat generation which can cause fire. Wrongly wired connections can destroy electric components and cause other damages.

5.1.2 Probes

The RJ12-plug connectors are meant for direct connection of probe. The plug connector is brought out through the hole in the housing and is properly secured by the PG7 gland. The connection of ready made probe is to be carried out as per enclosed data sheet. While connecting the probes, care should be taken to use the correct connection socket. The sockets are not coded and can get mixed up. The probe can get damaged due to wrong connection

5.2 Configuration

The connector configuration of ready made probe can be seen from the data sheet of probe.

The switching behaviour of the device is decided by the jumper connections below the input socket. The switching status of the device can be observed at the light emitting diode (LED). In active condition (=Relay closed) the LED glows.



Since the three inputs of the module are connected through "OR" logic, the jumper plugs „Switching polarity“ of the other two unused inputs should be kept in unwired inactive position. The associated LEDs under the unused input sockets will not glow. If this is not ensured, the relay will be always put on.

5.3 Adjustment of switching point

The adjustment of switching point is done as per probe type either by the trim potentiometer for impedance input ("SETP IMP") or for analog input ("SETP ANA"). For the analog input, the hysteresis can also be adjusted at the potentiometer („HYS ANA"). Further instructions about adjustment can be obtained from the data sheet of probe.

5.4 Adjustment of time delay

The configuration of time delay time is done by keeping the jumper plugs in the terminal strip „TIMER“ at the desired position. It must be set by only one bridge.

Connection and operation manual



Universal sensor switching module 24 V OEM-Version without housing

5.4.1 Operating voltage

12 V/24 V-AC/DC Model:

The operating voltage is connected at the terminals "SUPPLY VOLTAGE". The rating of nominal voltage is mentioned on the PCB, under the voltage connection and also on the relay and must be maintained as per specifications on the data sheet in order to ensure an error free functioning. A too high operating voltage can lead to damage of the device. Extremely low or unstable operating voltage leads to malfunctioning.

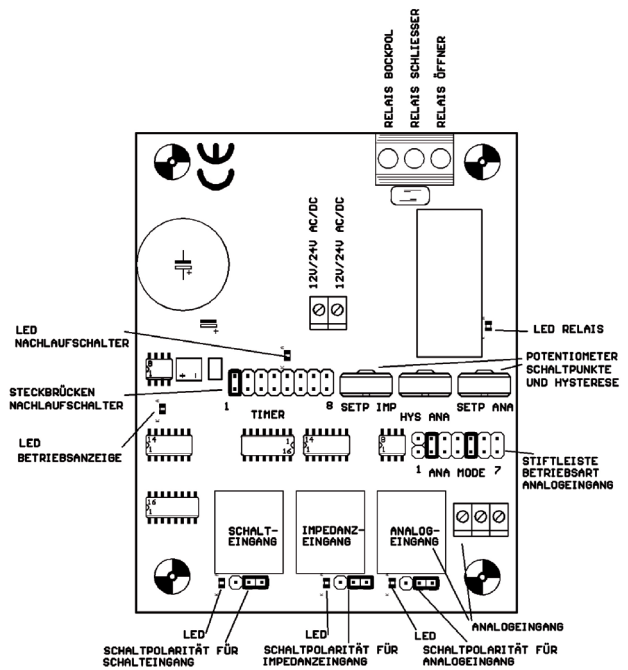

230 V AC model:

The connection with mains power supply should be done by only trained and authorized persons. The electrical connection is done through the 6-pin plug connector as per pin configuration. The device can be operated only with 230 V AC supply.

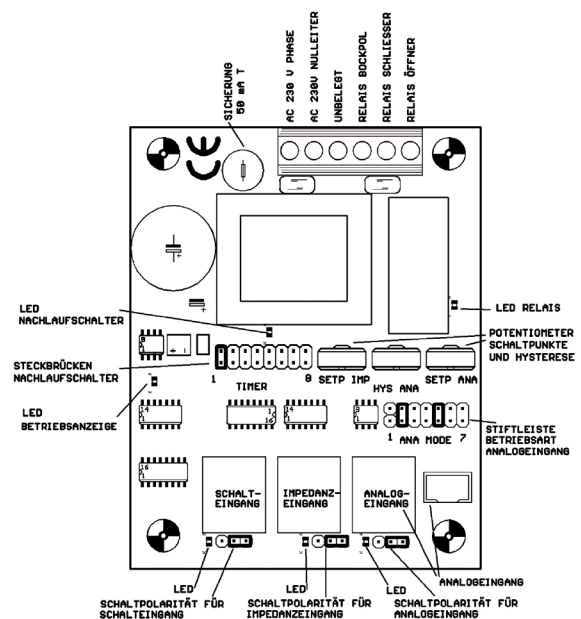

Universal sensor switching module 24 V OEM-Version without housing

5.4.2 Load circuit



The safety of load circuit, if required, should be taken care of through some external protection arrangement. (max. 5 A). To switch higher currents, corresponding switching elements should be used.

The changeover contacts of both the relays are potential free and are terminated at the connection socket. The connection to load is done as per the connector configuration. The NO contact of the relay is provided with a 390 V varistor for surge suppression.

6 Technical appendix



The technical appendix is useful for persons with adequate knowledge of electronics. The applicable safety regulations shall be duly followed! Connection and mounting work shall be carried out only after switching off the voltage supply.

The following instructions help in connection of your own probes at the input socket of module. However, this certainly needs necessary attention, as different operating voltages are present at the socket also. Sometimes, wrong connection may lead to damage of the components or result in failure of the module itself.



In the following description, the three inputs have been explained separately as these are also functionally independent of each other. Since the inputs are "OR" connected before the time delay switch, the jumper plug „Switching polarity“ of the other two unused inputs must be plugged in the inactive position. The LEDs below the unused input sockets may not glow.

Touching the electronic components in switched off condition is also to be avoided. Electronic components can get damaged due to electrostatic discharge process. ESD protection measures should be duly observed!

6.2 Switching input

6.2.1 Circuit diagram

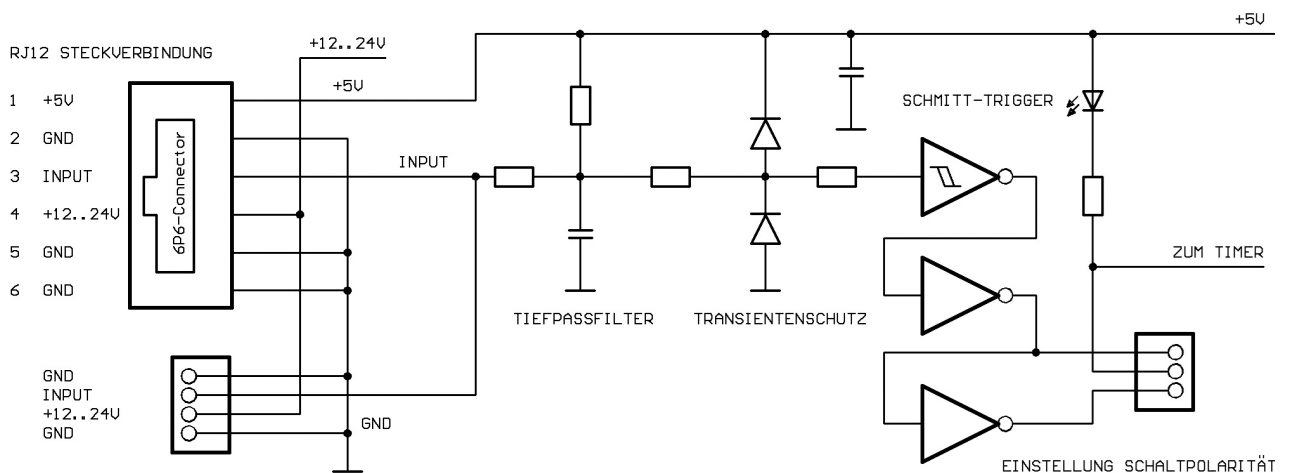

6.2.2 Functional description

The switching input is meant for connection of all switching sensors like REED-switch or contacts. The contact is connected at the RJ12 plug connector from GND (pin 2,5 or 6) to INPUT (pin 3).

As soon as the contact opens, the input level goes to high through the internal pull-up resistance. The Schmitt trigger is directed towards the high pass filter and transient protection. The switching point of Schmitt-Trigger lies at approx. 1.5 V (low) and 3.5 V (high). The switching polarity can be selected by the jumper connections at the output of two series connected inverters. The signal triggers the internal timer, which in turn switches on the relay at the output stage. The switching status of output is indicated by LED.

Connection and operation manual



Universal sensor switching module 24 V OEM-Version without housing

6.2.3 Configuration of switching input socket (RJ12)

Pin	Function	Description
1	+5 V	Operating voltage 5 V
2	GND	Device ground
3	INPUT	Input (Switch contact)
4	+12...24 V	Operating voltage 12...24 V
5	GND	Device ground
6	GND	Device ground

View of contacts on the plug!

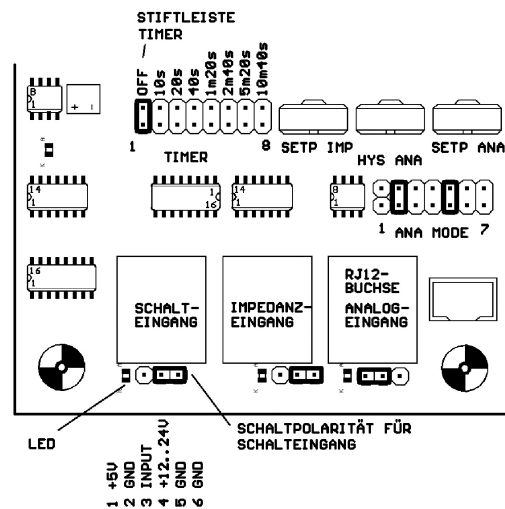
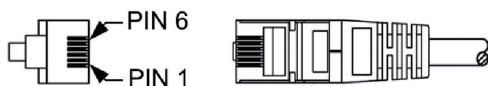

6.2.4 Adjustment and configuration

In switching input, only switching polarity can be configured. In the right position, the NC contact of the relay is triggered. In the left position, the switch mode is reversed, that means the NO contact of the relay is triggered.

6.2.5 Operating voltage connection



An operating voltage of 5 V is available at pin 1 of RJ12 socket to feed supply to external switching amplifiers. The voltage is stabilised and short circuit protected conforming to specification for integrated voltage regulators 78L05. The maximum current output should not exceed 10 mA in total. Applying external voltage leads to damage of components!

A rectified DC operating voltage is available at pin 4 of RJ12 socket to feed supply to external components. This voltage is between 12 V and 30 V DC depending upon the model and supply voltage at input. The supply is un stabilised and without short circuit protection. The maximum current output should not exceed 25 mA in total.

6.3 Impedance input

6.3.1 Circuit diagram

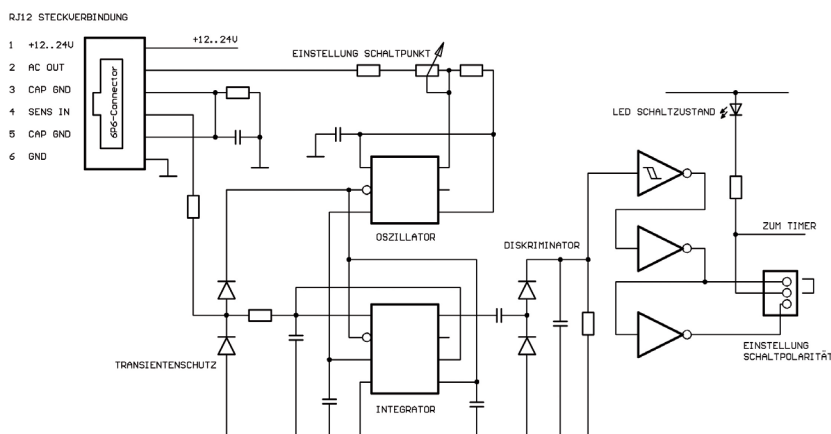

Connection and operation manual



Universal sensor switching module 24 V OEM-Version without housing

6.3.2 Functional description

The impedance input is especially suitable for electrolytic type of sensors like conductance probes and level indicators, foam sensor, humidity and dew formation sensors, material moisture content probe or water/leakage probe. The operating principle is based on an AC voltage measurement that prevents the measuring current from creating electrochemical effects.

The evaluation is done based on the series impedance of a sensor which is connected between AC OUT and SENS IN terminals, or by the parallel impedance of a probe (e.g. an interdigital structure) connected between SENS IN and CAP GND terminals. In such a case, a resistance of 0.47 k is inserted between the AC OUT and SENS IN terminals.

The RC-oscillator generates a rectangular voltage waveform of approx. 3 kHz frequency. The measuring current is integrated over the RC-network through the preset potentiometer and the sensor placed in series (between AC OUT and SENS IN), and the saw tooth voltage waveform is evaluated at the capacitor. The discriminator controls the overshooting of specified signal amplitude at the integrator of Schmitt-trigger and both the inverters.

The switching polarity can be selected by the jumper connections at the output of two series connected inverters. The signal triggers the internal Timer, which in turn switches the relay at the output stage. The switching status of output is indicated over the LED.

A fixed resistance (approx. 0.47 kΩ) is placed instead of the sensor as a conductance switch between AC OUT and SENS IN. In such a case, the sensor is connected between SENS IN and CAP GND terminals and modulated through the capacitive leakage current of signal amplitude. This type of operation is ideal for conductance measurement in liquids or for detecting presence of water.

6.3.3 Configuration of input socket RJ12

Pin	Function	Description
1	+12...24 V	Operating voltage 12...24 V
2	AC OUT	AC output
3	CAP GND	Capacitive ground
4	SENS IN	Evaluation input
5	CAP GND	Capacitive ground
6	GND	Device ground

View of contacts on the plug!

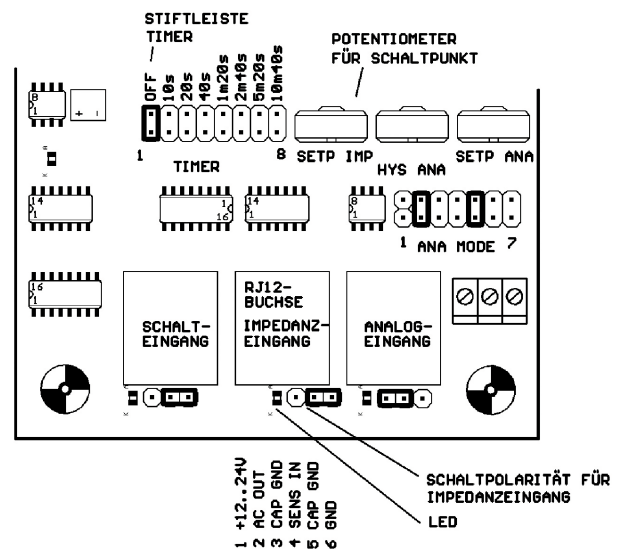
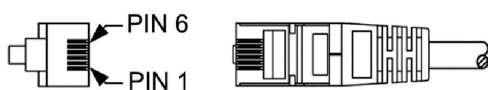

6.3.4 Adjustment and configuration

For impedance input, the switching polarity can be configured with the three pin terminal strip below input. The switching point of impedance can be adjusted with the potentiometer „SETP IMP“. The two other potentiometers have no other effect on the input. The Hysteresis is not adjustable.

6.3.5 Operating voltage connection



A rectified DC operating voltage is available at pin 1 of RJ12 socket to feed supply to external components. This voltage is between 12 V and 30 V DC depending upon the device model and module operating voltage at input and is unbalanced and without short circuit protection. The maximum current output should not exceed 25 mA in total.

Connection and operation manual

Universal sensor switching module 24 V OEM-Version without housing

6.4 Analog input

6.4.1 Circuit diagram

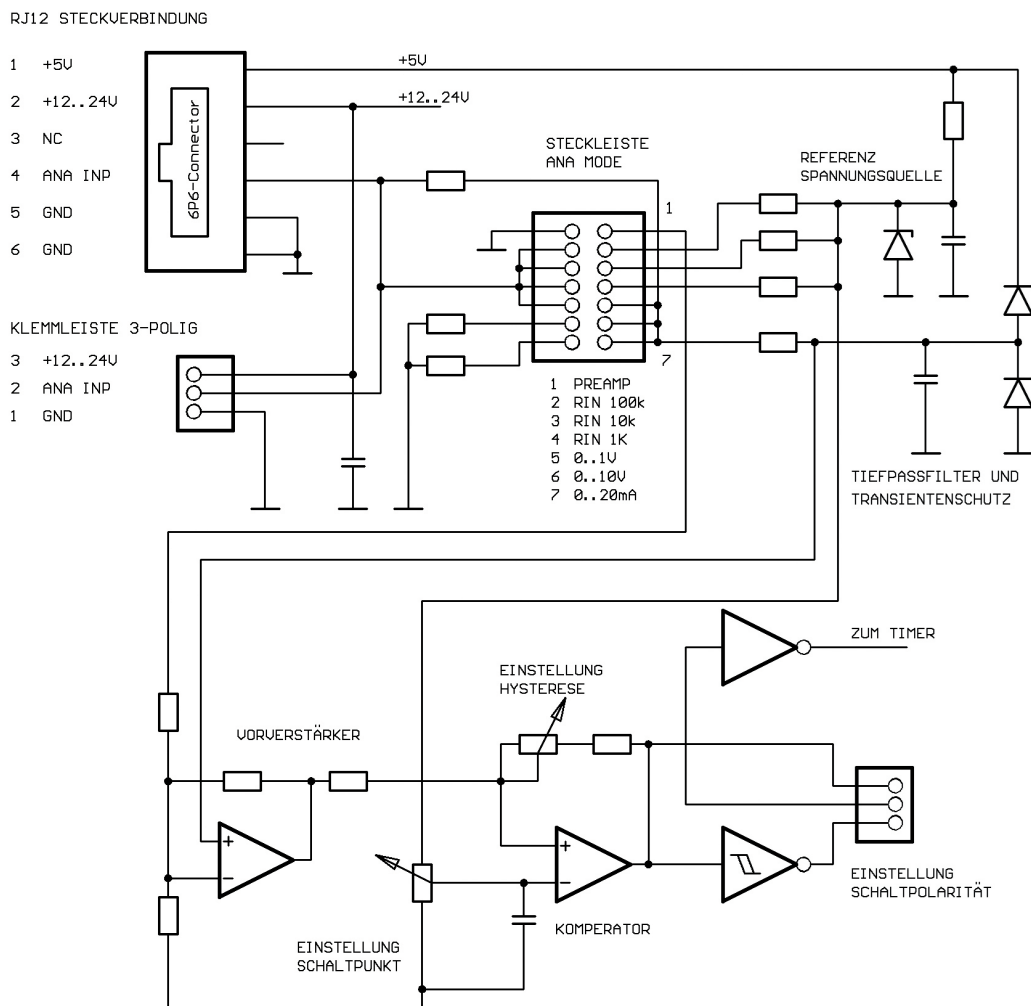

6.4.2 Functional description

The analog input is to be adapted over a pin contact strip for various types of sensors and industrial probes.

In order to also use resistive sensors as probes, there is possibility of applying the reference voltage to the sensor through a configurable preset resistor, which works as a voltage divider.

The signal is first pre-amplified and then evaluated with a comparator. In each case, the switching point and hysteresis can be adjusted through a potentiometer.

The switching polarity can be selected by the jumper connections at the output of two series connected inverters. The signal triggers the internal Timer, which in turn switches on the relay at the output stage. The switching status of output is indicated over the LED.

Connection and operation manual



Universal sensor switching module 24 V OEM-Version without housing

6.4.3 Configuration of analog input socket RJ12

Pin	Function	Description
1	+5 V	Betriebsspannung 5 V
2	+12...24 V	Operating voltage 12...24 V
3	NC	Unoccupied
4	ANA INP	Evaluation input
5	GND	Device ground
6	GND	Device ground/Shielding

View of contacts on the plug!

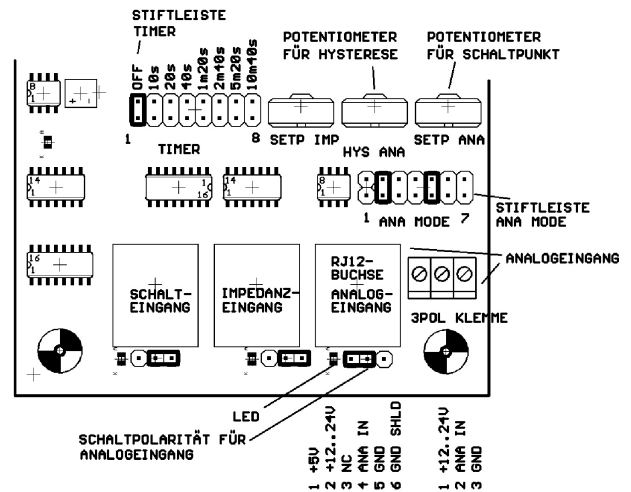
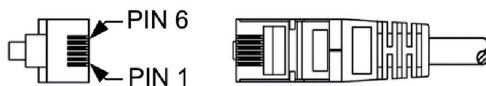

6.4.4 Adjustment and configuration

For impedance input, the switching polarity can be configured with the three pin terminal strip below input. The switching point can be adjusted with the potentiometer „SETP ANA“. The hysteresis can be adjusted at the potentiometer „HYS ANA“ i.e. the difference between switching ON and switching OFF point.







The input amplifier is to be programmed for different modes of operation with the jumper connection „ANA MODE“:

The analog input can be configured over a wide range through the jumper connections:

Pin	Function	Description
1	PREAMP	Increase the amplification by a factor of 1.6
2	RIN 100 k	Divider resistance for impedance measurement up to 100 k
3	RIN 10 k	Divider resistance for impedance measurement up to 10 k
4	RIN 1 k	Divider resistance for impedance measurement up to 1 k
5	0...1 V	Bridging the input resistance for 0...1 V or 0...20 mA
6	0...10 V	Connection of a divider resistance for voltage input 0...10 V
7	0...20 mA	Connection of a shunt for current measurement

Universal sensor switching module 24 V OEM-Version without housing

6.4.5 Operating modes

Sketch	Description
	Impedance input 100 k: All such components are suitable as sensors in which the resistance value is a function of the measured parameter e.g. LDRs (photo resistors) or NTCs (temperature sensors). The sensor with a resistance value of 0...100 k Ω is connected at the RJ12 socket between ANA INP (pin 3) and GND (pin 2).
	Same as (1), however for sensors with resistance value of 0...10 k
	Same as (1), however for sensors with resistance value of 0..1 k
	Voltage input 0...10 V for industrial transducer with voltage output. The probe is connected at the RJ12 socket between ANA INP (pin 3) and GND (pin 2).
	Same as (4) however for voltage input 0...1 V
	Current input 0...20 mA for industrial transducer with current output. The probe is connected at the RJ12 socket between ANA INP (pin 3) and GND (pin 2). The probe current, which flows from ANA IN to ground, is measured. The shunt in the sensor switch has a resistance value of 50 Ω .
	By additional bridging of the pins at pos. 1 of the terminal strip, the gain of pre-amplifier can be increased by a factor 1.6. Combined with other modes of operation, the following input ranges also emerge out: (1) 0...63 k Ω (2) 0...6,3 k Ω ; (3) 0...630 Ω ; (4) 0...0,63 V (5) 0...6,3 V (6) 0...12,6 mA



Caution! The current input is of low ohmic value (50 Ω) and is not protected against inadvertent entry of external voltages! The voltage and resistance measuring range are protected against external voltages up to a level of 20 V. High voltage can lead to failure of components.

6.4.6 Operating voltage connection



An operating voltage of 5 V is available at pin 1 of RJ12 socket is available to feed supply to external circuit amplifiers. The voltage is stabilised and short circuit protected conforming to specification for integrated voltage regulators 78L05. The maximum current output should not exceed 10 mA in total. Applying external voltage leads to damage of components!



A rectified DC operating voltage is available at pin 4 of RJ12 socket to feed supply to external components. This voltage is between 12 V and 30 V DC depending upon the device model and module operating voltage at input. The supply is unstabilised and without short circuit protection. The maximum current output should not exceed 25 mA in total.

6.5 Time delay switch

A digital time delay switch is integrated in the module, which can be adjusted over a wide range. The applications are many, for example, for direct triggering of cooling units or pumps, in order to avoid short time running time of the units.

The time delay switch ensures that the load remains switched on for a certain extra time period even after the switching criterion is not fulfilled further. The delay timer is reset by a renewed switching requirement during the time delay span and begins to recount.

Connection and operation manual



Universal sensor switching module 24 V OEM-Version without housing

6.5.1 Jumper connections

The time delay is digitally adjusted over 8 jumper connections. Only one jumper must be inserted in each case!

Pin	Function
1	Inactive, approx 1 sec.
2	approx. 10 sek.
3	approx. 20 sek.
4	approx. 40 sek.
5	approx. 1 min. 20 sek
6	approx. 2 min. 40 sek
7	approx. 5 min 20 sek
8	approx. 10 min 40 sek
This typical time can show a tolerance of approx. +/- 20 %.	

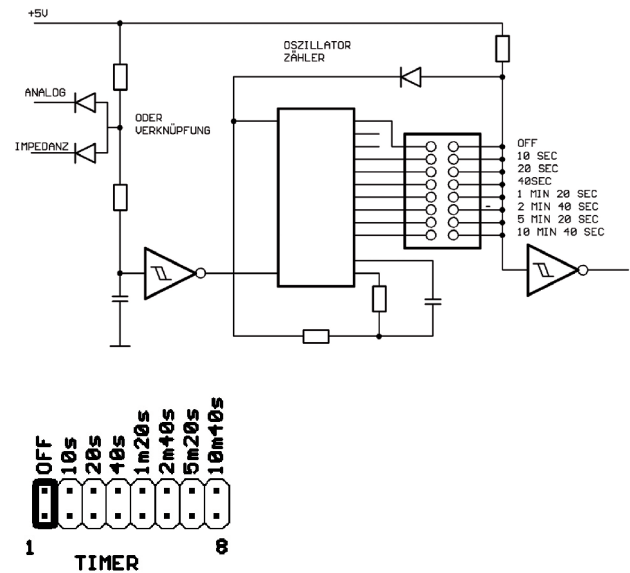

6.6 Relay



The relay on the module has a changeover contact and can also trigger heavy loads. The safety of the load circuit must be carried out through some external protection (NO contact max. 5 A T, NC contact max 2 A T). To switch higher currents, corresponding switching units should be used.

The NO contact is provided with a surge protection varistor VZ05/390V. The operating limits of components are to be taken care of!

7 Guarantee

Hearty congratulations on the purchase of this high quality product! The quality of our products is constantly monitored within the framework of our Quality Management systems as per ISO 9001 standards. Nevertheless, if still there are any reasons for complaint, we are ready to rectify the shortcomings free of charge within the guarantee period of 24 months, if it is evident that the defect is due to some mistake on our part.

Prerequisite for the fulfilment of guarantee service is that the details of defect should be informed to us immediately and within the stipulated guarantee period.

Of course, damages due to unintended use or non-compliance of operating instructions are excluded from this guarantee coverage. Moreover, defective sensors or sensing units and also calibration service are not covered in the guarantee.

The serial number on the product should not be changed, damaged or removed.

Apart from the guarantee service, if any essential repairs are required to be carried out, the service is free. However, further services and also postage and packing expenses are chargeable.

Compensation demands on the basis of claim for liability or damages during the guarantee period are excluded and these are, in general, not legally covered.



Connection and operation manual



Universal sensor switching module 24 V OEM-Version without housing

7.1 Repair and calibration service

During the tenure of guarantee period, we are very much at your disposal with our service support. For any malfunctioning, you can simply send back the product to us with a short description of problems observed. Please don't forget to mention your telephone number to enable us contact you for any possible queries.

We shall inform you about the likely amount of repair charges before taking up the repair activity. The cost estimate is provided free. The postage and packing charges for return are to be added over and above the repair costs.

In our calibration laboratory, we can also calibrate your measuring and testing devices with repeatability of National standards. Please contact us, we would be pleased to send you a non-committal offer!

Serviceadresse:
B+B Thermo-Technik GmbH
Heinrich-Hertz-Str. 4
78166 Donaueschingen
Germany
tel 0771.83160
fax 0771.8316-50
info@bb-sensors.com
www.bb-sensors.com

Attention

Please avoid extreme mechanical and inappropriate exposure.

The device/product is not suitable for potential explosive areas and medical-technical applications.

